

## SCHUTZROSETTEN-GARNITUR

Edelstahl matt

GRIFFWERK Schutzrosetten-Garnitur geeignet für den Einsatz im Privat- und Objektbereich.

- Hochwertiger rostfreier Edelstahl 1.4301
- Langlebig durch hohe Korrosionsbeständigkeit der Garnitur
- Verschraubung mit M5-Schrauben
- Schutzrosetten-Garnitur im eingebauten Zustand ohne sichtbare Schrauben/Montage- oder Demontageöffnungen im Außenbereich
- Zylinderüberstand 11-14 mm möglich (bei PZ)
- Zylinderüberstand 10-15 mm möglich (bei ZA)
- Standardtürstärke: 38-50 mm

## PROTECTION ROSE SET

stainless steel matt

GRIFFWERK Protective rosette fittings suitable for use in Private and commercial areas.

- High-quality stainless steel 1.4301
- Durable due to high corrosion resistance of the clothing
- Screw connection with M5 screws
- Protective rosette set in installed condition without visible screws/ mounting or dismantling openings in exterior area
- Cylinder projection 11-14 mm possible (with PZ)
- Cylinder projection 10-15 mm possible (with ZA)
- Standard door thickness: 38-50 mm



KNOPF R1  
knob R1

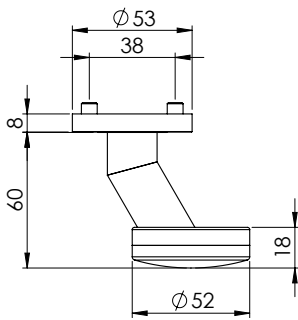
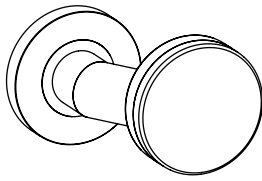

KNOPF R2  
knob R2

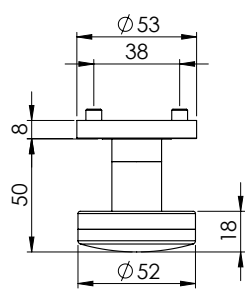
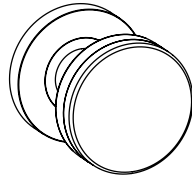

KNOPF R3  
knob R3

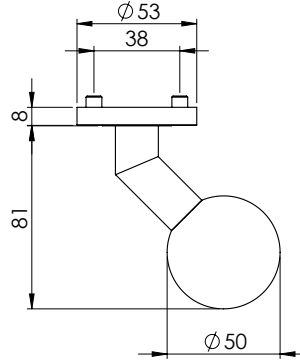
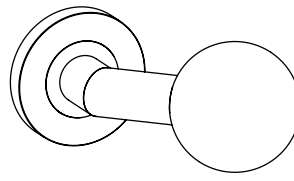

KNOPF R4  
knob R4

